



VM8016

LOW THERMAL MUX MODULE

USER'S MANUAL

**P/N: 82-0037-000
Rev. September 23, 2008**

VXI Technology, Inc.

**2031 Main Street
Irvine, CA 92614-6509
(949) 955-1894**



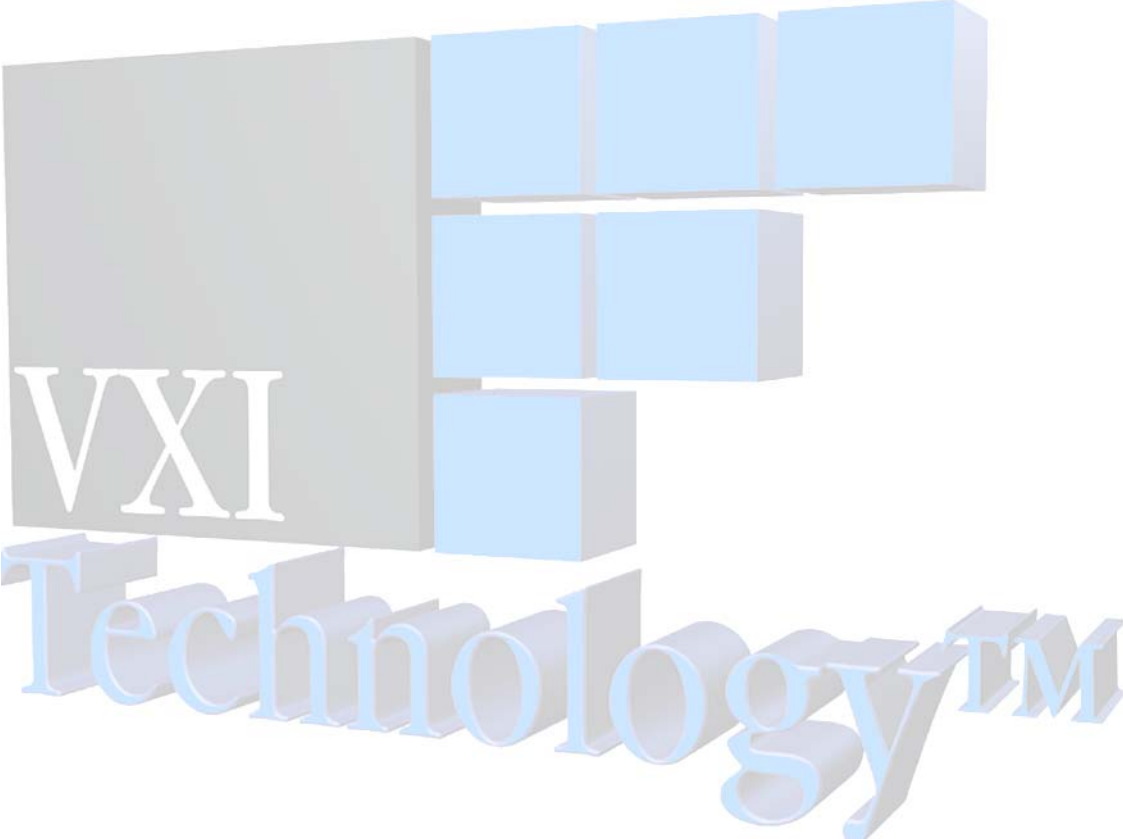

TABLE OF CONTENTS

INTRODUCTION

TABLE OF CONTENTS	3
Certification	6
Warranty	6
Limitation of Warranty	6
Restricted Rights Legend.....	6
DECLARATION OF CONFORMITY	7
GENERAL SAFETY INSTRUCTIONS.....	9
Terms and Symbols	9
Warnings	9
SUPPORT RESOURCES	11
SECTION 1.....	13
INTRODUCTION	13
Introduction	13
General Description.....	14
VM8016 Specifications	16
SECTION 2.....	17
PREPARATION FOR USE.....	17
Installation	17
Calculating System Power and Cooling Requirements	17
Setting the Chassis Backplane Jumpers.....	17
Setting the Logical Address.....	18
Front Panel Interface Wiring	18
SECTION 3.....	21
PROGRAMMING.....	21
Introduction	21
Notation	23
REGISTER ACCESS	24
SECTION 4.....	27
COMMAND DICTIONARY	27
Introduction	27
Alphabetical Command Listing.....	27
Command Dictionary.....	31
IEEE 488.2 COMMON COMMANDS	32
*CLS.....	32
*ESE.....	33
*ESR?.....	34
*IDN?	35
*OPC	36
*RST.....	37
*SRE.....	38
*STB?.....	39
*TRG	40
*TST?	41
*WAI.....	42
INSTRUMENT SPECIFIC SCPI COMMANDS.....	43
ROUTe:CLOSe	44
ROUTe:DELay	45
ROUTe:OPEN.....	46
ROUTe:SPECial	47
ROUTe:TYPE	48

REQUIRED SCPI COMMANDS.....	49
STATus:OPERation:CONDition?	49
STATus:OPERation:ENABle.....	50
STATus:OPERation:EVENT?	51
STATus:PRESet	52
STATus:QUEStionable:CONDition?	53
STATus:QUEStionable:ENABle	54
STATus:QUEStionable:EVENT	55
SYSTem:ERRor?	56
SYSTem:VERSion?	57
INDEX.....	59

CERTIFICATION

VXI Technology, Inc. (VTI) certifies that this product met its published specifications at the time of shipment from the factory. VTI further certifies that its calibration measurements are traceable to the United States National Institute of Standards and Technology (formerly National Bureau of Standards), to the extent allowed by that organization's calibration facility, and to the calibration facilities of other International Standards Organization members.

WARRANTY

The product referred to herein is warranted against defects in material and workmanship for a period of three years from the receipt date of the product at customer's facility. The sole and exclusive remedy for breach of any warranty concerning these goods shall be repair or replacement of defective parts, or a refund of the purchase price, to be determined at the option of VTI.

For warranty service or repair, this product must be returned to a VXI Technology authorized service center. The product shall be shipped prepaid to VTI and VTI shall prepay all returns of the product to the buyer. However, the buyer shall pay all shipping charges, duties, and taxes for products returned to VTI from another country.

VTI warrants that its software and firmware designated by VTI for use with a product will execute its programming when properly installed on that product. VTI does not however warrant that the operation of the product, or software, or firmware will be uninterrupted or error free.

LIMITATION OF WARRANTY

The warranty shall not apply to defects resulting from improper or inadequate maintenance by the buyer, buyer-supplied products or interfacing, unauthorized modification or misuse, operation outside the environmental specifications for the product, or improper site preparation or maintenance.

VXI Technology, Inc. shall not be liable for injury to property other than the goods themselves. Other than the limited warranty stated above, VXI Technology, Inc. makes no other warranties, express or implied, with respect to the quality of product beyond the description of the goods on the face of the contract. VTI specifically disclaims the implied warranties of merchantability and fitness for a particular purpose.

RESTRICTED RIGHTS LEGEND

Use, duplication, or disclosure by the Government is subject to restrictions as set forth in subdivision (b)(3)(ii) of the Rights in Technical Data and Computer Software clause in DFARS 252.227-7013.

VXI Technology, Inc.
2031 Main Street
Irvine, CA 92614-6509 U.S.A.

DECLARATION OF CONFORMITY

Declaration of Conformity According to ISO/IEC Guide 22 and EN 45014

MANUFACTURER'S NAME	VXI Technology, Inc.
MANUFACTURER'S ADDRESS	2031 Main Street Irvine, California 92614-6509
PRODUCT NAME	Low Thermal Mux Module
MODEL NUMBER(S)	VM8016
PRODUCT OPTIONS	All
PRODUCT CONFIGURATIONS	All

VXI Technology, Inc. declares that the aforementioned product conforms to the requirements of the Low Voltage Directive 73/23/EEC and the EMC Directive 89/366/EEC (inclusive 93/68/EEC) and carries the "CE" mark accordingly. The product has been designed and manufactured according to the following specifications:

SAFETY	EN61010 (2001)
EMC	EN61326 (1997 w/A1:98) Class A CISPR 22 (1997) Class A VCCI (April 2000) Class A ICES-003 Class A (ANSI C63.4 1992) AS/NZS 3548 (w/A1 & A2:97) Class A FCC Part 15 Subpart B Class A EN 61010-1:2001

The product was installed into a C-size VXI mainframe chassis and tested in a typical configuration.

I hereby declare that the aforementioned product has been designed to be in compliance with the relevant sections of the specifications listed above as well as complying with all essential requirements of the Low Voltage Directive.

August 2006



Steve Mauga, QA Manager

GENERAL SAFETY INSTRUCTIONS

Review the following safety precautions to avoid bodily injury and/or damage to the product. These precautions must be observed during all phases of operation or service of this product. Failure to comply with these precautions, or with specific warnings elsewhere in this manual, violates safety standards of design, manufacture, and intended use of the product.

Service should only be performed by qualified personnel.

TERMS AND SYMBOLS

These terms may appear in this manual:

- WARNING** Indicates that a procedure or condition may cause bodily injury or death.
- CAUTION** Indicates that a procedure or condition could possibly cause damage to equipment or loss of data.

These symbols may appear on the product:



ATTENTION - Important safety instructions

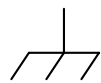

Frame or chassis ground



Indicates that the product was manufactured after August 13, 2005. This mark is placed in accordance with *EN 50419, Marking of electrical and electronic equipment in accordance with Article 11(2) of Directive 2002/96/EC (WEEE)*. End-of-life product can be returned to VTI by obtaining an RMA number. Fees for take-back and recycling will apply if not prohibited by national law.

WARNINGS

Follow these precautions to avoid injury or damage to the product:

- Use Proper Power Cord** To avoid hazard, only use the power cord specified for this product.
- Use Proper Power Source** To avoid electrical overload, electric shock, or fire hazard, do not use a power source that applies other than the specified voltage.
- Use Proper Fuse** To avoid fire hazard, only use the type and rating fuse specified for this product.

WARNINGS (CONT.)**Avoid Electric Shock**

To avoid electric shock or fire hazard, do not operate this product with the covers removed. Do not connect or disconnect any cable, probes, test leads, etc. while they are connected to a voltage source. Remove all power and unplug unit before performing any service. ***Service should only be performed by qualified personnel.***

Ground the Product

This product is grounded through the grounding conductor of the power cord. To avoid electric shock, the grounding conductor must be connected to earth ground.

Operating Conditions

To avoid injury, electric shock or fire hazard:

- Do not operate in wet or damp conditions.
- Do not operate in an explosive atmosphere.
- Operate or store only in specified temperature range.
- Provide proper clearance for product ventilation to prevent overheating.
- DO NOT operate if any damage to this product is suspected. ***Product should be inspected or serviced only by qualified personnel.***

Improper Use

The operator of this instrument is advised that if the equipment is used in a manner not specified in this manual, the protection provided by the equipment may be impaired. Conformity is checked by inspection.

SUPPORT RESOURCES

Support resources for this product are available on the Internet and at VXI Technology customer support centers.

VXI Technology World Headquarters

VXI Technology, Inc.
2031 Main Street
Irvine, CA 92614-6509

Phone: (949) 955-1894
Fax: (949) 955-3041

VXI Technology Cleveland Instrument Division

5425 Warner Road
Suite 13
Valley View, OH 44125

Phone: (216) 447-8950
Fax: (216) 447-8951

VXI Technology Lake Stevens Instrument Division

VXI Technology, Inc.
1924 - 203 Bickford
Snohomish, WA 98290

Phone: (425) 212-2285
Fax: (425) 212-2289

Technical Support

Phone: (949) 955-1894
Fax: (949) 955-3041
E-mail: support@vxitech.com



Visit <http://www.vxitech.com> for worldwide support sites and service plan information.

SECTION 1

INTRODUCTION

INTRODUCTION

The VM8016 VXI module is a high precision, low thermal relay multiplexer designed for use in high accuracy applications.

The instrument uses the message-based word-serial interface for programming and data movement, as well as supporting direct register access for very high-speed data throughput. The VM8016 command set conforms to the SCPI standard for consistency and ease of programming.

The VM8016 is a member of the VXI Technology, Inc. VMIP™ (*VXI Modular Instrumentation Platform*) family and is available as a 16-, 32-, or 48-channel, single-wide C-size VXIbus module. In addition to these three standard configurations, the VM8016 may be combined with any of the other members of the VMIP™ family to form a customized and highly integrated instrument (see Figure 1-1). This allows the user to reduce system size and cost by combining the VM8016 with two other instrument functions in a single-wide C-size VXIbus module.

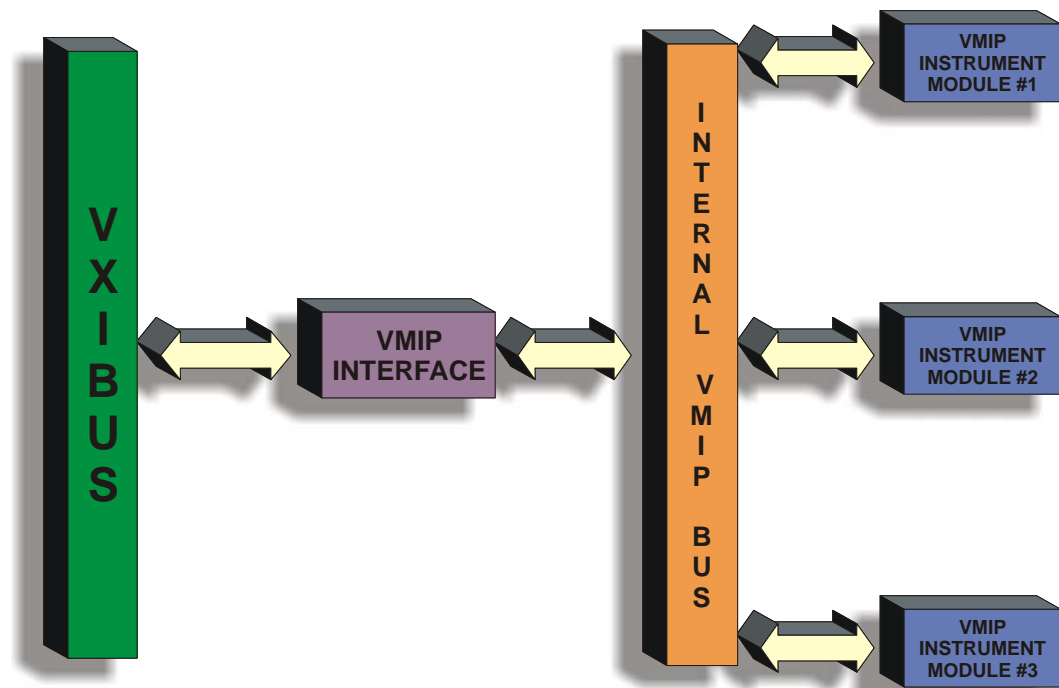

FIGURE 1-1: VMIP™ PLATFORM

GENERAL DESCRIPTION

The VM8016 has two banks of eight channels each and can be configured for either 16-channel/2-wire or 8-channel/4-wire use. As part of the VMIP family of instruments, it can be combined with up to two other modules to form a high-density VXIbus instrument that fully utilizes the capabilities of the VMIP. This gives the capability of up to 48-channel/2-wire or 24-channel/4-wire configurations.

When the module is configured as 16-channel/2-wire, the two banks function independently and one channel from each bank can be selected at the same time. When the module is configured as an 8-channel/4-wire, the two banks function together in parallel. For example, Channel 1 and Channel 9 would be paired to make up one 4-wire output, Channels 2 and 10 would be paired, and so on. See Figure 1-2.

When the module is in normal mode, only one channel from each bank (or one set of 4-wire channels) can be selected at a time. To select multiple channels, the module must be in Special mode. See the [ROUTE:]SPECial command in the Command Dictionary section for more information on Normal or Special mode.

The VM8016 is programmed using word-serial message-based commands that are SCPI compatible. SCPI commands are available to configure the VM8016 as either a 2- or 4-wire multiplexer. Commands can also be used to program delays between relay closures to synchronize with external devices such as DMMs, or to simply to open or close relays. See the Command Dictionary section for command functions.

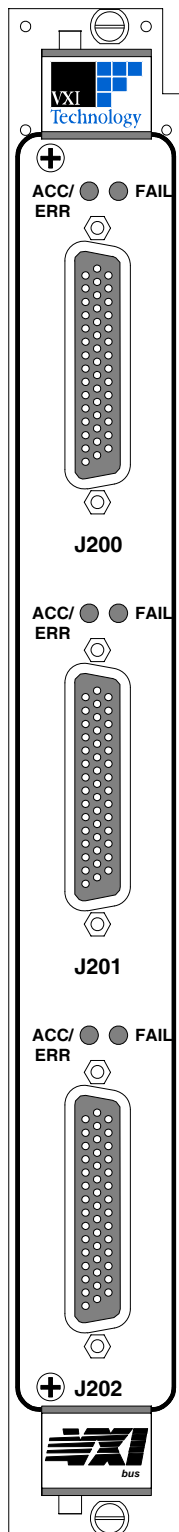

FIGURE 1-2: FRONT PANEL LAYOUT

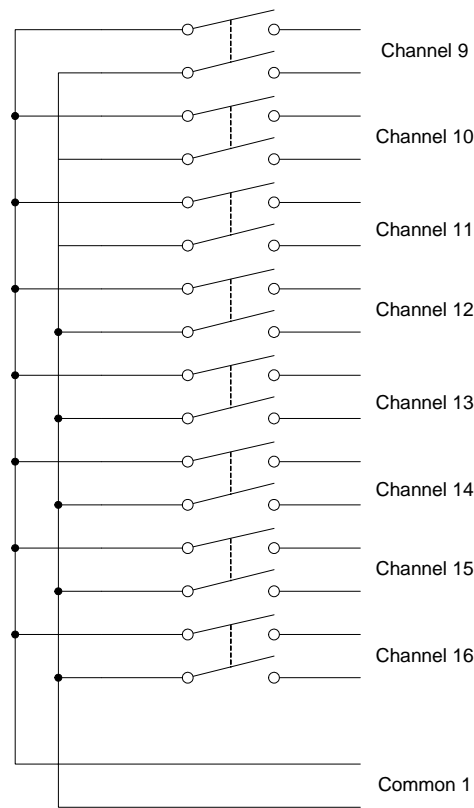
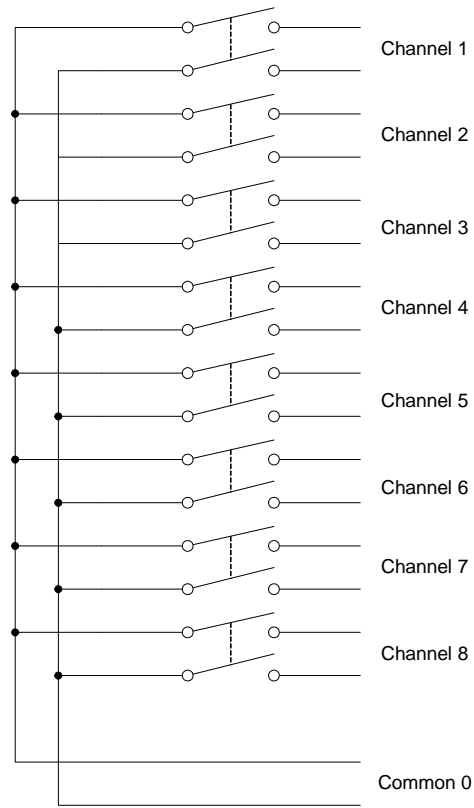

FIGURE 1-3: VM8016 16 CHANNEL LAYOUT

VM8016 SPECIFICATIONS

GENERAL SPECIFICATIONS	
MAXIMUM SWITCHING VOLTAGE	200 VDC or 200 V peak ac
MAXIMUM SWITCHING CURRENT	0.5 A
MAXIMUM CARRY CURRENT	1.0 A
MAXIMUM POWER PER CHANNEL	10 W
MAXIMUM THERMAL EMF	< 1 μ V
CLOSED CHANNEL PATH RESISTANCE	< 0.75 Ω
INSULATION RESISTANCE	10 ¹¹ Ω (between two points)
CLOSED CHANNEL CAPACITANCE	50 pF
MAXIMUM BANDWIDTH	50 MHz
MAXIMUM RELAY LIFE	100 x 10 ⁶ operations (1 V, 10 mA)

SECTION 2

PREPARATION FOR USE

INSTALLATION

When the VM8016 is unpacked from its shipping carton, the contents should include the following items:

- (1) VM8016 VXIbus module
- (1) VM8016 Module User's Manual (this manual)

All components should be immediately inspected for damage upon receipt of the unit.

Once the VM8016 is assessed to be in good condition, it may be installed into an appropriate C-size or D-size VXIbus chassis in any slot other than slot 0. The chassis should be checked to ensure that it is capable of providing adequate power and cooling for the VM8016. Once the chassis is found to be adequate, the VM8016's logical address and the chassis' backplane jumpers should be configured prior to the VM8016's installation.

CALCULATING SYSTEM POWER AND COOLING REQUIREMENTS

It is imperative that the chassis provide adequate power and cooling for this module. Referring to the chassis user's manual, confirm that the power budget for the system (the chassis and all modules installed therein) is not exceeded and that the cooling system can provide adequate airflow at the specified backpressure.



It should be noted that if the chassis cannot provide adequate power to the module, the instrument may not perform to specification or possibly not operate at all. In addition, if adequate cooling is not provided, the reliability of the instrument will be jeopardized and permanent damage may occur. Damage found to have occurred due to inadequate cooling would also void the warranty of the module.

SETTING THE CHASSIS BACKPLANE JUMPERS

Please refer to the chassis user's manual for further details on setting the backplane jumpers.

SETTING THE LOGICAL ADDRESS

The logical address of the VM8016 is set by a single 8-position DIP-switch located near the module's backplane connectors (this is the only switch on the module). The switch is labeled with positions 1 through 8 and with an ON position. Switches pushed toward the ON legend signify a logic 1; switches pushed away from the ON legend signify a logic 0. The switch located at position 1 is the least significant bit while the switch located at position 8 is the most significant bit. See Figure 2-1 for examples of setting the logical address switch.

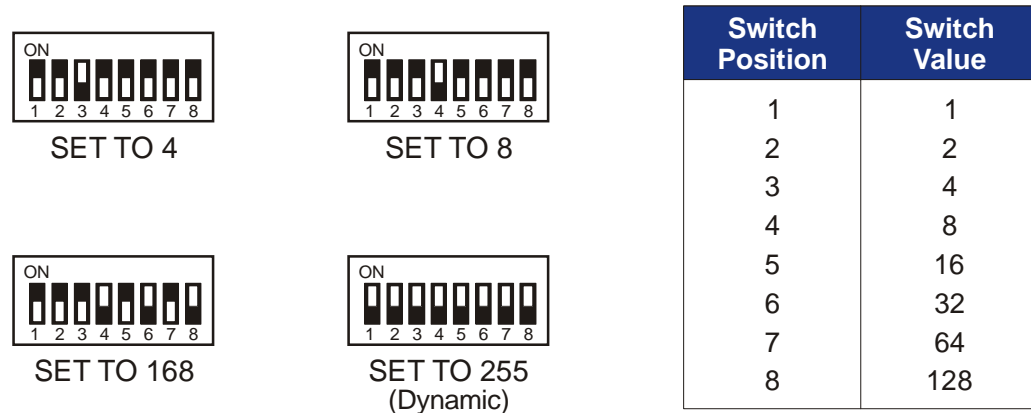

FIGURE 2-1: LOGICAL ADDRESS SWITCH SETTING EXAMPLES

The VMIP may contain three separate instruments and will allocate logical addresses as required by the VXIbus specification (revisions 1.3 and 1.4). The logical address of the instrument is set on the VMIP carrier. The VMIP logical addresses must be set to an even multiple of 4 *unless dynamic addressing is used*. Switch positions 1 and 2 must always be set to the OFF position. Therefore, only addresses of 4, 8, 12, 16, ... 252 are allowed. The address switch should be set for one of these legal addresses and the address for the second instrument (the instrument in the center position) will automatically be set to the switch set address plus one; while the third instrument (the instrument in the lowest position) will automatically be set to the switch set address plus two. If dynamic address configuration is desired, the address switch should be set for a value of 255 (All switches set to ON). Upon power-up, the slot 0 resource manager will assign the first available logical addresses to each instrument in the VMIP module.

If dynamic address configuration is desired, the address switch should be set for a value of 255. (All switches set to ON). Upon power-up, the slot 0 resource manager will assign the first available logical addresses to each instrument in the VMIP module.

FRONT PANEL INTERFACE WIRING

The 16-channel version (VM8016-1) has a connector labeled J201 that contains all signals for this instrument. The 32-channel version (VM8016-2) has J201 and J202 provided, while the 48-channel version (VM8016-3) has J200, J201, and J202. The wiring for each of these connectors is identical and since each group of 16 channels is treated as a separate instrument, a VM8016-3 has three Channel 1s, three Channel 2s, three Channel 3s, etc.

Regardless of whether the VM8016 is configured with other VM8016 modules or with other VMIP modules, each module is treated as an independent instrument in the VXIbus chassis. As such, each group has its own FAIL and ACCESS light.

TABLE 2-1: VM8016 PIN ASSIGNMENTS

PIN	SIGNAL	PIN	SIGNAL	PIN	SIGNAL	PIN	SIGNAL
1	+CHANNEL 1	12	+CHANNEL 12	23	-CHANNEL 8	34	-CHANNEL 14
2	+CHANNEL 2	13	SHIELD	24	-CHANNEL 9	35	+CHANNEL 15
3	+CHANNEL 3	14	+COMMON 0	25	-CHANNEL 10	36	-CHANNEL 15
4	+CHANNEL 4	15	+COMMON 1	26	-CHANNEL 11	37	+CHANNEL 16
5	+CHANNEL 5	16	-CHANNEL 1	27	-CHANNEL 12	38	-CHANNEL 16
6	+CHANNEL 6	17	-CHANNEL 2	28	SHIELD	39	SHIELD
7	+CHANNEL 7	18	-CHANNEL 3	29	-COMMON 0	40	SHIELD
8	+CHANNEL 8	19	-CHANNEL 4	30	-COMMON 1	41	FP OPEN
9	+CHANNEL 9	20	-CHANNEL 5	31	+CHANNEL 13	42	GND
10	+CHANNEL 10	21	-CHANNEL 6	32	-CHANNEL 13	43	GND
11	+CHANNEL 11	22	-CHANNEL 7	33	+CHANNEL 14	44	FP TRIG

The connector for the VM8016 board is a 44-pin female high-density DSUB type. A solder cup type mating connector is provided with each unit. Typical part numbers for the mating connectors include:

AMP P/N:	748366-1	SHELL
AMP P/N:	748333-4	CONTACT
AMP P/N:	90430-1	HAND CRIMP TOOL

The pin locations for J200, J201 and J202 are shown in Figure 2-2.

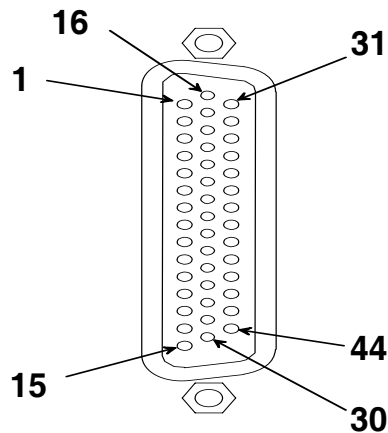
**FIGURE 2-2: J200, J201, AND J202 PIN LOCATIONS**

SECTION 3

PROGRAMMING

INTRODUCTION

The VM8016 is a VXIbus message-based device whose command set is compliant with the Standard Command for Programmable Instruments (SCPI) programming language.

All module commands are sent over the VXIbus backplane to the module. Commands may be in upper, lower, or mixed case. All numbers are sent in ASCII decimal unless otherwise noted.

The module recognizes SCPI commands. SCPI is a tree-structured language based on IEEE-STD-488.2 Specifications. It utilizes the IEEE-STD-488.2 Standard command, and the device dependent commands are structured to allow multiple branches off the same trunk to be used without repeating the trunk. To use this facility, terminate each branch with a semicolon. As an example, **POLarity**, **STATe**, and **TTLTrg** are all branches off the **RESet:OUTPut** trunk and can be combined as follows:

```
RESet:OUTPut:POLarity POS;STATe 1;TTLTrg 4
```

The above command has the same effect as the following three:

```
RESet:OUTPut:POLarity POS  
RESet:OUTPut:STATe 1  
RESet:OUTPut:TTLTrg 4
```

See the Standard Command for Programmable Instruments (SCPI) Manual, Volume 1: Syntax & Style, Section 6, for more information.

The SCPI commands in this section are listed in upper and lower case. Character case is used to indicate different forms of the same command. Keywords can have both a short form and a long form (some commands only have one form). The short form uses just the keyword characters in uppercase. The long form uses the keyword characters in uppercase plus the keyword characters in lowercase. Either form is acceptable. Note that there are no intermediate forms. All characters of the short form or all characters of the long form must be used. Short forms and long forms may be freely intermixed. The actual commands sent can be in upper case, lower case or mixed case (case is only used to distinguish short and long form for the user). As an example, these commands are all correct and all have the same effect:

```
RESet:OUTPut:STATe 1
reset:output:state 1
RESET:OUTPUT:STATE 1
RES:OUTPut:STATe 1
RES:OUTP:STATE 1
RES:OUTP:STAT 1
res:outp:stat 1
```

The following command is **not** correct because it doesn't use the complete short form of **OUTPut**:

```
RES:OUT:STAT 1
```

(incorrect syntax - missing "p" - only **outp** or **output** is correct)

All of the SCPI commands also have a query form unless otherwise noted. Query forms contain a question mark (?). The query form allows the system to ask what the current setting of a parameter is. The query form of the command generally replaces the parameter with a question mark (?). Query responses do not include the command header. This means only the parameter is returned: no part of the command or "question" is returned.

When character data is used for a parameter, both short and long forms are recognized. If the command has a query form with character response data, the short form is always returned in upper case. As an example, to find out what the current trigger source setting is use the following command:

```
RES:OUTP:POL?
```

The response would be:

```
POS
```

This tells the user that the Reset Output signal polarity has been set to a positive edge.

NOTATION

Keywords or parameters enclosed in square brackets ([]) are optional. If the optional part is a keyword, the keyword can be included or left out. Omitting an optional parameter will cause its default to be used.

Parameters are enclosed by angle brackets (< >). Braces ({ }), or curly brackets, are used to enclose one or more parameters that may be included zero or more times. A vertical bar (|), read as "or", is used to separate parameter alternatives.

REGISTER ACCESS

The VM8016 provides direct register access for faster data access. The register map is shown in Table 3-1.

TABLE 3-1: VM8016 A16 MEMORY

Offset	Description
3E	
3C	
3A	
38	
36	
34	
32	
30	
2E	
2C	
2A	
28	
26	
24	
22	
20	Relay Address 1 - 16
1E	
1C	
1A	
18	
16	[A32 Pointer Low]
14	[A32 Pointer High]
12	[A24 Pointer Low]
10	[A24 Pointer High]
E	Data Low
C	Data High
A	Response [/Data Extended]
8	Protocol [/Signal] Register
6	[Offset Register]
4	Status / Control Register
2	Device Type
0	ID Register

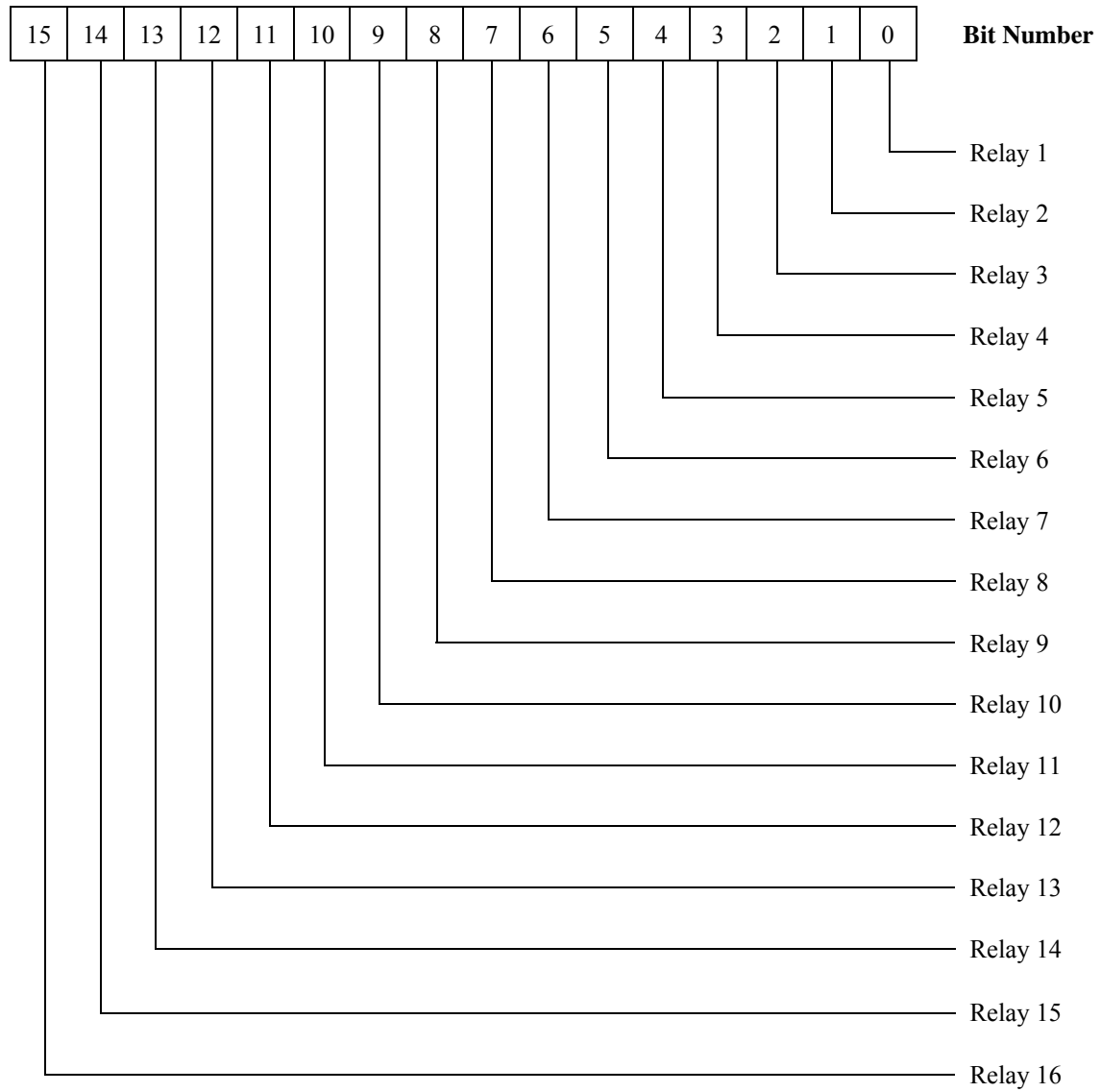

FIGURE 3-1: RELAY REGISTER

SECTION 4

COMMAND DICTIONARY

INTRODUCTION

This section presents the instrument command set. It begins with an alphabetical list of all the commands supported by the VM8016 divided into three sections: IEEE 488.2 commands, the instrument specific SCPI commands and the required SCPI commands. With each command is a brief description of its function, whether the command's value is affected by the *RST command and its default value.

The remainder of this section is devoted to describing each command, one per page, in detail. The description is presented in a regular and orthogonal way assisting the user in the use of each command. Every command entry describes the exact command and query syntax, the use and range of parameters and a complete description of the command's purpose.

ALPHABETICAL COMMAND LISTING

The following tables provide an alphabetical listing of each command supported by the VM8016 along with a brief description. If an X is found in the column titled *RST, then the value or setting controlled by this command is possibly changed by the execution of the *RST command. If no X is found, then *RST has no effect. The default column gives the value of each command's setting when the unit is powered up or when a *RST command is executed.

TABLE 4-1: IEEE 488.2 COMMON COMMANDS

Command	Description	*RST	Reset Value
*CLS	Clear the Status Register.	X	
*ESE	Set the Event Status Enable Register.		N/A
*ESR?	Query the Standard Event Status Register		N/A
*IDN?	Query the module identification string.		N/A
*OPC	Set the OPC bit in the Event Status Register	X	0
*RST	Reset the module to a known state		N/A
*SRE	Set the service request enable register		N/A
*STB?	Query the Status Byte Register.		N/A
*TRG	Causes a trigger event to occur.		N/A
*TST?	Starts and reports a self-test procedure.		N/A
*WAI	Halts execution and queries		N/A

TABLE 4-2: INSTRUMENT SPECIFIC SCPI COMMANDS

Command	Description	*RST	Reset Value
ROUTE:CLOSE	Connect a channel to its output pins	X	All channels Open
ROUTE:DElay	Sets the relay settling time	X	0.002 sec
ROUTE:OPEN	Disconnect a channel from its output pins	X	All channels Open
ROUTE:SPECial	Allows for single or multiple channel operation	X	Single
ROUTE:TYPE	Select 2-wire or 4-wire operation	X	2-wire

TABLE 4-3: REQUIRED SCPI COMMANDS

Command	Description	*RST	Reset Value
STATus:OPERation:CONDition?	Query the Operation Status Condition Register.	X	
STATus:OPERation:ENABLE	Sets the Operation Status Enable Register.	X	
STATus:OPERation[:EVENT]?	Query the Operation Status Event Register.	X	
STATus:PRESet	Presets the Status Register.	X	
STATus:QUEStionable:CONDition?	Query the Questionable Status Condition Register.	X	
STATus:QUEStionable:ENABLE	Sets the Questionable Status Enable Register.	X	
STATus:QUEStionable[:EVENT]?	Query the Questionable Status Event Register	X	
SYSTem:ERRor?	Query the Error Queue.	X	Clears queue
SYSTem:VERsion?	Query which version of the SCPI standard the module complies with.		N/A

COMMAND DICTIONARY

The remainder of this section is devoted to the actual command dictionary. Each command is fully described on its own page. In defining how each command is used, the following items are described:

Purpose	Describes the purpose of the command.
Type	Describes the type of event, such as type or setting.
Command Syntax	Details the exact command format
Command Parameters	Describes the parameters sent with the command and their legal parameters
*RST Value	Describes the value assumed when the *RST (reset) command is sent.
Query Syntax	Details the exact query form of the command.
Query Parameters	Describes the parameters sent with the command and their legal range. The default parameter values are assumed the same as in the command form unless described otherwise.
Query Response	Describes the format of the query response and the valid range of output.
Description	Describes in detail what the command does and refers to additional sources.
Examples	Presents the proper use of each command and its query (when available).
Related Commands	Lists commands that affect the use of this command or commands that are affected by this command.

IEEE 488.2 COMMON COMMANDS

*CLS

Purpose	Clears the Status Register.	
Type	IEEE488.2 Common Command	
Command Syntax	*CLS	
Command Parameters	None	
*RST Value	*RST performs all the functions of *CLS	
Query Syntax	None - Command Only	
Query Parameters	N/A	
Query Response	N/A	
Description	This command clears all event registers, clears the OPC flag and clears all queues (except the output queue).	
Examples	Command / Query	Response (Description)
	*CLS	
Related Commands	None	

***ESE**

Purpose	Sets the bits of the Event Status Enable Register.	
Type	IEEE488.2 Common Command	
Command Syntax	*ESE <mask>	
Command Parameters	<mask> = numeric ASCII value in the range of 0 to 255	
*RST Value	N/A	
Query Syntax	*ESE?	
Query Parameters	None	
Query Response	Numeric ASCII value from 0 to 255	
Description	<p>The Event Status Enable command is used to set the bits of the Event Status Enable Register. See ANSI/IEEE488.2-1987 section 11.5.1 for a complete description of the ESE register. A value of 1 in a bit position of the ESE register enables generation of the ESB (Event Status Bit) in the Status Byte by the corresponding bit in the ESR. If the ESB is set in the SRE register then an interrupt will be generated. See the ESR? command for details regarding the individual bits.</p> <p>The ESE register layout is:</p> <ul style="list-style-type: none"> Bit 0 - Operation Complete Bit 1 - Request Control (not used) Bit 2 - Query Error Bit 3 - Device Dependent Error (not used) Bit 4 - Execution Error Bit 5 - Command Error Bit 6 - User Request (not used) Bit 7 - Power On <p>The Event Status Enable query reports the current contents of the Event Status Enable Register.</p>	
Examples	Command / Query	Response (Description)
	*ESE 36 *ESE?	36
Related Commands	*ESR?	

***ESR?**

Purpose	Queries and clears the Standard Event Status Register.	
Type	IEEE488.2 Common Command	
Command Syntax	None - Query Only	
Command Parameters	N/A	
*RST Value	N/A	
Query Syntax	ESR?	
Query Parameters	None	
Query Response	Numeric ASCII value from 0 to 255	
Description	<p>The Event Status Register query - queries and clears the contents of the Standard Event Status Register. This register is used in conjunction with the ESE register to generate the ESB (Event Status Bit) in the Status Byte.</p> <p>The layout of the ESR is:</p> <ul style="list-style-type: none"> Bit 0 - Operation Complete Bit 1 - Request Control (not used) Bit 2 - Query Error Bit 3 - Device Dependent Error (not used) Bit 4 - Execution Error Bit 5 - Command Error Bit 6 - User Request (not used) Bit 7 - Power On <p>The Operation Complete bit is set by the VM8016 when it receives an *OPC command.</p> <p>The Query Error bit is set when data is over-written in the output queue. This could occur if one query is followed by another without reading the data from the first query.</p> <p>The Execution Error bit is set when an execution error is detected. Errors that range from -200 to -299 are execution errors.</p> <p>The Command Error bit is set when a command error is detected. Errors that range from -100 to -199 are command errors.</p> <p>The Power On bit is set when the module is first powered on or after it receives a reset via the VXI Control Register. Once the bit is cleared (by executing the *ESR? command) it will remain cleared.</p>	
Examples	Command / Query	Response (<i>Description</i>)
	*ESR?	4
Related Commands	*ESE	

***IDN?**

Purpose	Queries the module for its identification string.	
Type	IEEE488.2 Common Command	
Command Syntax	None - Query Only	
Command Parameters	N/A	
*RST Value	N/A	
Query Syntax	*IDN?	
Query Parameters	None	
Query Response	ASCII character string	
Description	The Identification query returns the identification string of the VM8016 module. The response is divided into four fields separated by commas. The first field is the manufacturer's name, the second field is the model number, the third field is an optional serial number and the fourth field is the firmware revision number. If a serial number is not supplied, the third field is set to 0 (zero).	
Examples	Command / Query	Response (<i>Description</i>)
	*IDN?	VXI Technology Inc.,VM8016,0,1.00
Related Commands	None	

***OPC**

Purpose	Sets the OPC bit in the Event Status Register.	
Type	IEEE488.2 Common Command	
Command Syntax	*OPC	
Command Parameters	None	
*RST Value	*RST removes any pending *OPC request	
Query Syntax	*OPC?	
Query Parameters	None	
Query Response	1	
Description	The Operation Complete command sets the OPC bit in the Event Status Register when all pending operations have completed. The Operation Complete query will return a 1 to the output queue when all pending operations have completed, specifically, the operations of connecting or disconnecting channels (ROUTE:CLOSE or ROUTE:OPEN). When a relay changes, the operation isn't complete until the relay settles.	
Examples	Command / Query	Response (<i>Description</i>)
	*OPC *OPC?	1
Related Commands	*WAI	

***RST**

Purpose	Resets the module's hardware and software to a known state.	
Type	IEEE488.2 Common Command	
Command Syntax	*RST	
Command Parameters	None	
*RST Value	N/A	
Query Syntax	None - Command Only	
Query Parameters	N/A	
Query Response	N/A	
Description	The Reset command resets the module's hardware and software to a known state. See the command index at the beginning of this chapter for the default parameter values set by this command.	
Examples	Command / Query	Response (<i>Description</i>)
	*RST	
Related Commands	None	

***SRE**

Purpose	Set the service request enable register.	
Type	IEEE 488.2 Common Command	
Command Syntax	*SRE <mask>	
Command Parameters	<mask> = Numeric ASCII value in the range of 0 to 255	
*RST Value	N/A	
Query Syntax	*SRE?	
Query Parameters	None	
Query Response	Numeric ASCII value from 0 to 255	
Description	<p>The service request enable mask is used to control which bits in the status byte generate back plane interrupts. If a bit is set in the mask that newly enables a bit set in the status byte and interrupts are enabled, the module will generate a REQUEST TRUE event via an interrupt. See the *STB? Command for the layout of bits. Note: Bit 6 is always internally cleared to zero as required by IEEE 488.2 section 11.3.2.3.</p> <p>The layout of the Service Request Enable Register is:</p> <ul style="list-style-type: none"> Bit 0 - Unused Bit 1 - Unused Bit 2 - Error Queue Has Data Bit 3 - Questionable Status Summary (not used) Bit 4 - Message Available Bit 5 - Event Status Summary Bit 6 - 0 Bit 7 - Operation Status Summary 	
Examples	Command / Query	Response (Description)
	*SRE 4 *SRE?	4
Related Commands	None	

***STB?**

Purpose	Queries the Status Byte Register.	
Type	IEEE488.2 Common Command	
Command Syntax	None - Query Only	
Command Parameters	N/A	
*RST Value	N/A	
Query Syntax	*STB?	
Query Parameters	None	
Query Response	Numeric ASCII value from 0 to 255	
Description	<p>The Read Status Byte query fetches the current contents of the Status Byte Register. See the IEEE 488.2 specification for additional information regarding the Status Byte Register and its use.</p> <p>The layout of the Status Byte Register is:</p> <ul style="list-style-type: none"> Bit 0 - Unused Bit 1 - Unused Bit 2 - Error Queue Has Data Bit 3 - Questionable Status Summary (not used) Bit 4 - Message Available Bit 5 - Event Status Bit (ESB) Bit 6 - Master Summary Status Bit 7 - Operation Status Summary 	
Examples	Command / Query	Response (<i>Description</i>)
	*STB?	16
Related Commands	None	

***TRG**

Purpose	Causes a trigger event to occur.	
Type	IEEE488.2 Common Command	
Command Syntax	*TRG	
Command Parameters	None	
*RST Value	N/A	
Query Syntax	None - Command Only	
Query Parameters	N/A	
Query Response	N/A	
Description	The Trigger command is included for SCPI compliance and has no effect on the VM8016.	
Examples	Command / Query	Response (Description)
	*TRG	
Related Commands	None	

***TST?**

Purpose	Causes a self-test procedure to occur and queries the results.	
Type	IEEE488.2 Common Command	
Command Syntax	None - Query Only	
Command Parameters	N/A	
*RST Value	N/A	
Query Syntax	*TST?	
Query Parameters	None	
Query Response	Numeric ASCII value from 0 to 255	
Description	The Self-Test query causes the VM8016 to run a self-test.	
Examples	Command / Query	Response (<i>Description</i>)
	*TST?	0 (<i>A return of 0 indicates self-test passed.</i>)
Related Commands	None	

***WAI**

Purpose	Halts execution of additional commands and queries until the No Operation Pending message is true.	
Type	IEEE488.2 Common Command	
Command Syntax	*WAI	
Command Parameters	None	
*RST Value	N/A	
Query Syntax	None - Command Only	
Query Parameters	N/A	
Query Response	N/A	
Description	The Wait to Continue command halts the execution of additional commands and queries until the No Operation Pending message is true. This command makes sure that all previous commands have been executed before proceeding. It provides a way of synchronizing the module with its commander, specifically, the operations of connecting or disconnecting channels (ROUTE:CLOSE or ROUTE:OPEN). When a relay changes, the operation isn't complete until the relay settles.	
Examples	Command / Query	Response (<i>Description</i>)
	*WAI	
Related Commands	*OPC	

INSTRUMENT SPECIFIC SCPI COMMANDS

ROUTE:CLOSE

Purpose	Connect a channel with its output pins.	
Type	Setting	
Command Syntax	[ROUTE:]CLOSE <channel>	
Command Parameters	<channel> = 1 2 3 4 5 6 7 8 9 10 11 12 13 14 15 16	
*RST Value	All channels open	
Query Syntax	[ROUTE:]CLOSE? <channel>	
Query Parameters	<channel> = 1 2 3 4 5 6 7 8 9 10 11 12 13 14 15 16	
Query Response	0 1 (0 = False (open), 1 = True (closed))	
Description	The Route Close command connects the indicated channel to the front panel Common connector. Channels 1 through 8 will be routed to Common0, and Channels 9 through 16 will be routed to Common1.	
Examples	Command / Query	Response (Description)
	CLOS 2 CLOS? 2	(Connects channel two to its front panel connector.) (Ask if Channel 2 is connected to the front panel Common connector. The response says it is connected.)
Related Commands	ROUTE:DElay ROUTE:OPEN	

ROUTe:DELAy

Purpose	Sets the relay settling time.	
Type	Setting	
Command Syntax	[ROUTe:]DELAy <delay time>	
Command Parameters	<delay time> = 0 to 1374 seconds at 0.000001 steps	
*RST Value	0.002 seconds	
Query Syntax	[ROUTe:]DELAy?	
Query Parameters	None	
Query Response	0 to 1374 at 0.000001 steps	
Description	The Route Delay command sets the relay settling time. The default setting of 0.002 is usually used.	
Examples	Command / Query	Response (Description)
	DEL 0.005 DEL?	(Sets the delay to 0.005 seconds.) 0.005 (Ask for the delay setting. The response says the delay is set to 0.005 seconds.)
Related Commands	ROUTe:CLOSe ROUTe:OPeN	

ROUTE:OPEN

Purpose	Disconnect a channel from its output pins.	
Type	Setting	
Command Syntax	[ROUTE:]OPEN <channel>	
Command Parameters	<channel> = 1 2 3 4 5 6 7 8 9 10 11 12 13 14 15 16	
*RST Value	All channels open	
Query Syntax	[ROUTE:]OPEN? <channel>	
Query Parameters	<channel> = 1 2 3 4 5 6 7 8 9 10 11 12 13 14 15 16	
Query Response	0 1 (0 = False (closed), 1 = True (open))	
Description	<p>The Route Open command disconnects the indicated channel from the front panel connector Common.</p> <p>If this command is used without the channel parameter, then all channels will be opened. If a query is made without the channel parameter, a 1 (or true) returned signifies that all channels are open, while a 0 (or false) returned means that at least one channel is closed.</p>	
Examples	Command / Query	Response (Description)
	OPEN 2	<i>(Disconnects Channel 2 from the front panel connector Common.)</i>
	OPEN? 2	<i>(Ask if Channel 2 is disconnected from the front panel connector Common. The response says it is disconnected.)</i>
	OPEN	<i>(Disconnects all channels from the front panel connector Common.)</i>
	OPEN?	<i>1 (Verifies that all channels are disconnected from the front panel connector Common.)</i>
Related Commands	ROUTE:CLOSE ROUTE:DELay	

ROUTe:SPECIAL

Purpose	Allows for single or multiple channel operation.	
Type	Setting	
Command Syntax	[ROUTe:]SPECIAL <boolean>	
Command Parameters	<boolean> = 0 1 OFF ON	
*RST Value	0	
Query Syntax	[ROUTe:]SPECIAL?	
Query Parameters	None	
Query Response	0 1	
Description	<p>The Route Special command allows more than one channel to be routed to the Common pins on the front panel connector. When Special is off, only one channel can be routed to each Common connection. Channels 1 through 8 can be routed to Common0, and Channels 9 through 16 can be routed to Common1. When Special is on, Channels 1 through 8 can be routed to Common0 simultaneously. Likewise, and Channels 9 through 16 can be routed to Common1 simultaneously.</p> <p>Route Special must be disabled to get make-before-break functionality.</p>	
Examples	Command / Query	Response (<i>Description</i>)
	SPEC ON SPEC?	1
Related Commands	ROUTe:CLOSe ROUTe:DELay ROUTe:OPeN	

ROUTE:TYPE

Purpose	Select 2-wire or 4-wire operation.	
Type	Setting	
Command Syntax	[ROUTE:]TYPE <type>	
Command Parameters	<type> = 2 4	
*RST Value	2	
Query Syntax	[ROUTE:]TYPE?	
Query Parameters	N/A	
Query Response	2 4	
Description	The Route Type command sets the device for 2-wire or 4-wire operation. For 2-wire operation, the 16 channels operate independently. For 4-wire operation, Channels 1 through 8 are paired with Channels 9 through 16. The default setting is for 2-wire operation.	
Examples	Command / Query	Response (<i>Description</i>)
	TYPE 4 TYPE?	4
Related Commands	ROUTE:CLOSe ROUTE:OPEN	

REQUIRED SCPI COMMANDS

STATus:OPERation:CONDition?

Purpose	Queries the Operation Status Condition Register.	
Type	Required SCPI command	
Command Syntax	None - Query Only	
Command Parameters	N/A	
*RST Value	N/A	
Query Syntax	STATus:OPERation:CONDition?	
Query Parameters	None	
Query Response	0	
Description	The Operation Status Condition Register query is provided for SCPI compliance only. The VM8016 does not alter the state of any of the bits in this register and always reports a 0.	
Examples	Command / Query	Response (<i>Description</i>)
	STAT : OPER : COND ?	0
Related Commands	None	

STATus:OPERation:ENABLE

Purpose	Sets the Operation Status Enable Register.	
Type	Required SCPI command	
Command Syntax	STATus:OPERation:ENABLE <NRF>	
Command Parameters	<NRF> = numeric ASCII value from 0 to 32767	
*RST Value	N/A	
Query Syntax	STATus:OPERation:ENABLE?	
Query Parameters	None	
Query Response	Numeric ASCII value from 0 to 32767	
Description	<p>The Operation Status Enable Register is included for SCPI.</p> <p>The register layout is as follows:</p> <ul style="list-style-type: none"> Bit 0 - Calibrating (not used on the VM8016) Bit 1 - Setting (not used on the VM8016) Bit 2 - Ranging (not used on the VM8016) Bit 3 - Sweeping (not used on the VM8016) Bit 4 - Measuring (not used on the VM8016) Bit 5 - Waiting for trigger (not used on the VM8016) Bit 6 - Waiting for arm (not used on the VM8016) Bit 7 - Correcting (not used on the VM8016) 	
Examples	Command / Query	Response (Description)
	STAT:OPER:ENAB 0 STAT:OPER:ENAB?	0
Related Commands	None	

STATus:OPERation:EVENT?

Purpose	Queries the Operation Status Event Register.	
Type	Required SCPI command	
Command Syntax	None - Query Only	
Command Parameters	N/A	
*RST Value	N/A	
Query Syntax	STATus:OPERation [:EVENT] ?	
Query Parameters	None	
Query Response	0	
Description	<p>The Status Operation Event Register query is included for SCPI compliance.</p> <p>The register layout is as follows:</p> <p>Bit 0 - Calibrating (not used on the VM8016) Bit 1 - Settling (not used on the VM8016) Bit 2 - Ranging (not used on the VM8016) Bit 3 - Sweeping (not used on the VM8016) Bit 4 - Measuring (not used on the VM8016) Bit 5 - Waiting for trigger (not used on the VM8016) Bit 6 - Waiting for arm (not used on the VM8016) Bit 7 - Correcting (not used on the VM8016)</p>	
Examples	Command / Query	Response (Description)
	STAT : OPER?	0
Related Commands	None	

STATus:PRESet

Purpose	Presets the Status Registers.	
Type	Required SCPI command	
Command Syntax	STATus:PRESet	
Command Parameters	None	
*RST Value	N/A	
Query Syntax	None - Command Only	
Query Parameters	N/A	
Query Response	N/A	
Description	The Status Preset command presets the Status Registers. The Operational Status Enable Register is set to 0 and the Questionable Status Enable Register is set to 0. This command is provided for SCPI compliance only.	
Examples	Command / Query	Response (<i>Description</i>)
	STAT : PRES	
Related Commands	None	

STATus:QUESTionable:CONDition?

Purpose	Queries the Questionable Status Condition Register.	
Type	Required SCPI command	
Command Syntax	None - Query Only	
Command Parameters	N/A	
*RST Value	N/A	
Query Syntax	STATus:QUESTionable:CONDition?	
Query Parameters	None	
Query Response	0	
Description	The Questionable Status Condition Register query is provided for SCPI compliance only. The VM8016 does not alter any of the bits in this register and a query always reports a 0.	
Examples	Command / Query	Response (<i>Description</i>)
	STAT : QUES : COND?	0
Related Commands	None	

STATus:QUESTIONable:ENABLE

Purpose	Sets the Questionable Status Enable Register.	
Type	Required SCPI command	
Command Syntax	STATus:QUESTIONable:ENABLE <NRF>	
Command Parameters	NRF = numeric ASCII value from 0 to 32767	
*RST Value	N/A	
Query Syntax	STATus:QUESTIONable:ENABLE?	
Query Parameters	None	
Query Response	Numeric ASCII value from 0 to 32767	
Description	<p>The Status Questionable Enable command sets the bits in the Questionable Status Enable Register. This command is provided only to comply with the SCPI standard.</p> <p>The Status Questionable Enable query reports the contents of the Questionable Status Enable Register. The VM8016 does not alter the bit settings of this register and will report the last programmed value.</p>	
Examples	Command / Query	Response (<i>Description</i>)
	STAT : QUES : ENAB 64 STAT : QUES : ENAB ?	64
Related Commands	None	

STATus:QUEStionable:EVENT

Purpose	Queries the Questionable Status Event Register.	
Type	Required SCPI command	
Command Syntax	None - Query Only	
Command Parameters	N/A	
*RST Value	N/A	
Query Syntax	STATus:QUEStionable[:EVENT]?	
Query Parameters	None	
Query Response	0	
Description	The Questionable Status Event Register is provided for SCPI compliance only. The VM8016 does not alter the bits in this register and queries always report a 0	
Examples	Command / Query	Response (<i>Description</i>)
	STAT : QUES ?	0
Related Commands	None	

SYSTem:ERRor?

Purpose	Queries the Error Queue	
Type	Required SCPI command	
Command Syntax	None - Query Only	
Command Parameters	N/A	
*RST Value	N/A	
Query Syntax	SYSTem:ERRor?	
Query Parameters	None	
Query Response	ASCII string	
Description	<p>The System Error query is used to retrieve error messages from the error queue. The error queue will maintain up to ten error messages. If additional errors occur, the queue will overflow and the tenth and subsequent error messages will be lost. In the case of an overflow, an overflow message will replace the tenth error message. See the SCPI standard Volume 2: Command Reference for details on errors and reporting them.</p>	
Examples	Command / Query	Response (<i>Description</i>)
	SYST : ERR?	-350 (<i>No error.</i>)
Related Commands	None	

SYSTem:VERsion?

Purpose	Queries the SCPI version number to which the VM8016 complies.	
Type	Required SCPI command	
Command Syntax	None - Query Only	
Command Parameters	N/A	
*RST Value	N/A	
Query Syntax	SYSTem:VERsion?	
Query Parameters	None	
Query Response	Numeric ASCII value	
Description	The System Version query reports version of the SCPI standard with which the VM8016 complies.	
Examples	Command / Query	Response (<i>Description</i>)
	SYST : VERS ?	1994.0
Related Commands	None	

INDEX

Symbol

*CLS.....	32
*ESE.....	33
*ESR?.....	34
*IDN?.....	35
*OPC.....	36
*OPC?.....	36
*RST.....	37
*SRE.....	38
*STB?.....	39
*TRG.....	40
*TST?.....	41
*WAI.....	42

2

2-wire.....	14, 48
-------------	--------

4

4-wire.....	14, 48
-------------	--------

B

backplane.....	21
banks.....	14

C

cable.....	10
clear.....	32
common.....	46
common connection.....	47
common connector.....	44
connector.....	19
cooling.....	17

D

default parameter.....	37
direct register access.....	13
dynamic address configuration.....	18

E

electric shock.....	10
error messages.....	56
errors.....	34
explosive atmosphere.....	10

G

grounding conductor.....	10
--------------------------	----

K

keyword.....	22, 23
--------------	--------

L

logical address.....	17, 18
----------------------	--------

M

message-based.....	13, 14, 21
--------------------	------------

N

normal mode.....	14
------------------	----

O

overheating.....	10
------------------	----

P

parameter.....	22, 23
parameters.....	27
pin locations.....	19
power.....	17, 18
power cord.....	10
probes.....	10
programming language.....	21

R

register.....	33, 34, 36, 38, 39, 49, 50, 51, 52, 53, 54, 55
register access.....	24
relay settling time.....	45
ROUTe:CLOSe.....	44
ROUTe:DELAy.....	45
ROUTe:OPEN.....	46
ROUTe:SPECial.....	47
ROUTe:TYPE.....	48

S

SCPI compatible.....	14
SCPI standard.....	13, 57
Special mode.....	14
STATus:OPERation:CONDition?.....	49
STATus:OPERation:ENABle.....	50
STATus:OPERation:EVENT?.....	51
STATus:PRESet.....	52
STATus:QUEStionable:CONDition?.....	53
STATus:QUEStionable:ENABle.....	54
STATus:QUEStionable:EVENT.....	55
synchronizing.....	42
syntax.....	21
SYSTEM:ERRor?.....	56
SYSTEM:VERSion?.....	57

T

temperature range.....	10
test leads.....	10
tree-structured language.....	21

V

ventilation.....	10
VMIP.....	13, 14, 18
VXI Modular Instrumentation Platform.....	13
VXIbus.....	13, 14, 17, 18, 21

W

WEEE.....	9
wet or damp conditions.....	10
word-serial.....	13, 14