



# **Sorensen**

## **DLM600 Series M6 Option for M9G, M130 or M131**

**Manual Addendum**





## 1.1 INTRODUCTION

### 1.1.1 M6 with GPIB M9G

The option M6, herein, will describe the operation and M9G remote programming option for the DLM600 series power supply with an Isolation and Polarity Reversal Relay PCB. This option is assembled as a self-contained unit with newly designed extended lower plate and top covers, which allow the user full isolation and reverse polarity capability for both output and external sense. These units measure 21 inches from the tip of the front panel controls to the rear panel output bars. They are about 8.5 inches wide and 1U tall. Illustrations of the DLM600's top, side, and rear views are shown on Pages 11 and 12 of this addendum.

### 1.1.2 M6 with Ethernet M130 and M131

This manual covers the M6 Option as it works in conjunction with M130 Remote Programming Ethernet Option and the M131 Slave Option, for the DLM600 Series power supplies. Specific information on M130 and M131 interface cards can be found in the DLM Series M130/M131 Ethernet Option Programming Manual, P/N M362797-03.

## 1.2 FEATURES and FUNCTIONS

Transient Response Specification is 1400us

Depth is 20"

**M9G** - All standard features remain as described in the DLM600 Series manual and in Section 1 of the M9 manual.

**M130/M131** - Ethernet M130 and M131 features in manual, P/N M362797-03, apply.

### 1.2.1 Additional Features and Functions

- Output voltage isolation from output load
- Output local or remote
- Output reverse polarity
- Relay hot-switch lock-out (ensures that the voltage across the relay contacts and the current through them, is near zero prior to changing relay states)
- Relay automatically disconnects (relays automatically latch Open when a shutdown occurs)

## 1.3 PROGRAMMABLE FUNCTIONS

**M9G** - All programmable functions remain as described in Section 1 of the M9 manual.

**M130/M131** - Ethernet M130 and M131 programmable functions listed in manual, P/N M362797-03 apply.

### 1.3.1 Additional Programmable Functions

- Remote Isolation Relay control
- Remote Local/Remote Sense Relay control
- Remote Reverse Polarity control

## 2.1 CONFIGURATION

### 2.1.1 Setup Procedure, M9G

The M9 and the Relay PCB options are installed at the factory. Use the setup procedure described in the M9 programming manual section 2 to configure the M9 and the Relay PCB for your system and application.

### 2.1.2 Setup Procedure, M130 and M131

The M6 is installed in the supply at the factory. The M6 card is not a user serviceable assembly.

### 2.1.3 Rear Panel M130/M131

Figure 2.1-1 and Figure 2.1-2 label the pertinent rear panel components for the typical M130 and M131 Ethernet option.

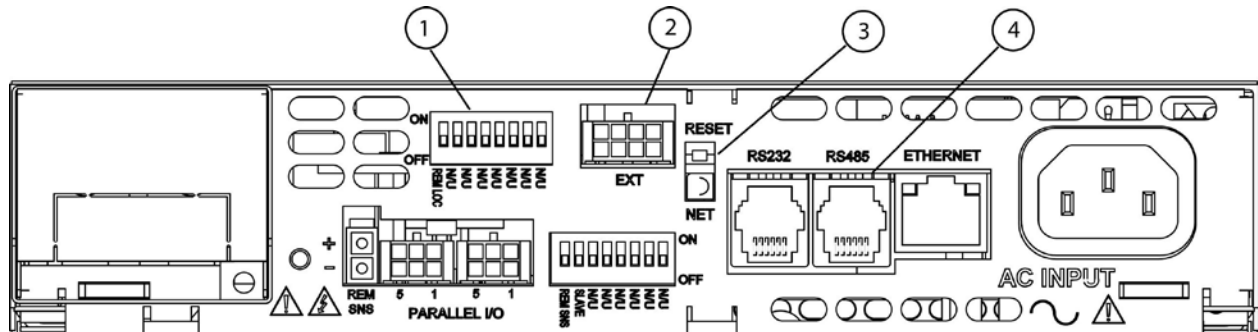

Figure 2.1-1 Typical Rear Panel of M130 Ethernet Option

- 1 – Configuration Switch
- 2 – External User Control Signal Connector
- 3 – (Not in M131) RESET switch and green dual-purpose NET LED
  - RESET switch: returns configuration parameters to factory default (must be depressed until NET LED blinks at least twice).
  - NET LED: when solid-lit, indicates Network Connectivity; blinking indicates Instrument ID. If the LED is off, there is no Ethernet connection found by the power supply.
- 4 – Connections for Ethernet (RJ-45) with built-in 10/100 indicator (on right top of the RJ45 connector) and an Activity indicator (on the left top). Also RJ-11 connectors for RS232 and RS485. (No RJ-45 connector on M131).

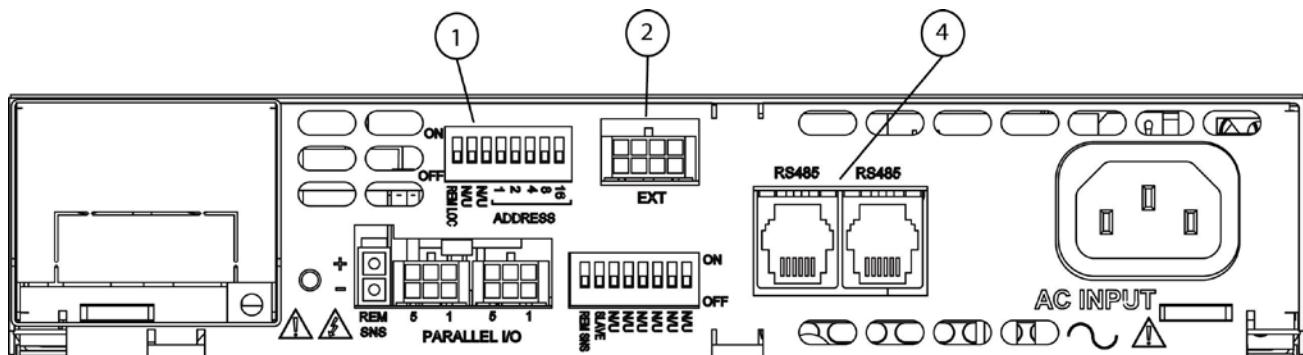
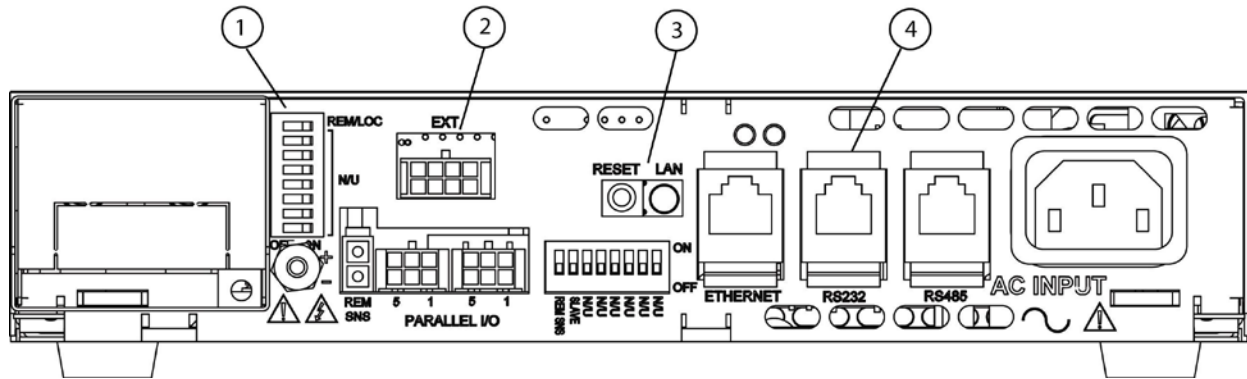

Figure 2.1-2 Typical Rear Panel of M131 Ethernet Option

## 2.1.4 Rear Panel M130/M131 with M6 Option,

Figure 2.1-3 and Figure 2.1-4 label the pertinent rear panel components for the M130 and M131 with M6 option.



**Figure 2.1-3 M130 Rear Panel with M6 Disconnect/Polarity Relay Option**

- 1 – Configuration Switch.
- 2 – External User Control Signal Connector
- 3 – (Not in M131) RESET switch and green dual-purpose NET LED.
  - RESET switch: returns configuration parameters to factory default (must be depressed until NET LED blinks at least twice).
  - NET LED: when solid-lit, indicates Network Connectivity; blinking indicates Instrument ID. If the LED is off, there is no Ethernet connection found by the power supply.
- 4 – Connections for Ethernet (RJ-45) with built-in 10/100 indicator (on right top of the RJ45 connector) and an Activity indicator (on the left top). Also RJ-11 connectors for RS232 and RS485. (No RJ-45 connector on M131).

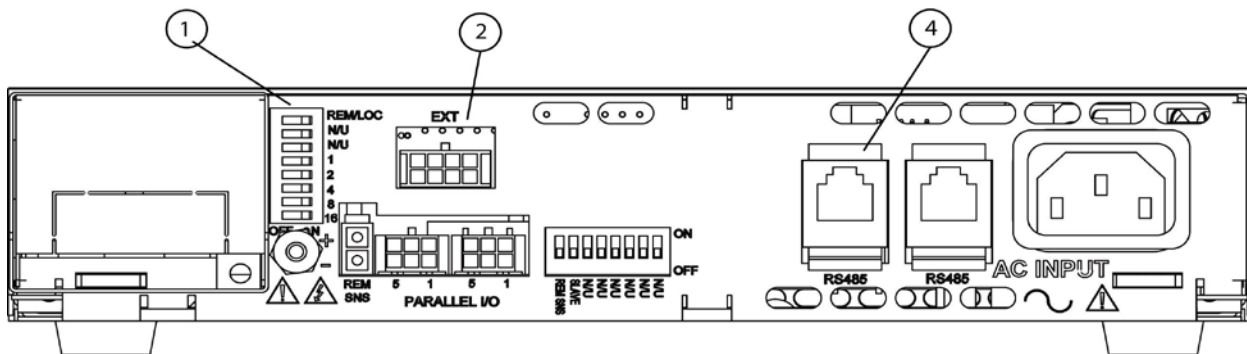

**Figure 2.1-4 M131 Rear Panel with M6 Disconnect/Polarity Relay Option**

### 2.1.5 Configuration Switch

The DIP switch is accessible from the rear panel to allow configuration of the supply with the installed M130/M131 for the user's particular system and application.

**Note:** On the Ethernet master, the rear panel switch gets set to Remote On, and all remaining switches are disregarded.

**Note:** Two types of DIP switches are utilized; toggle and rocker. For toggle switches, the shading indicates the position of the toggle switch. For rocker switches, the shading indicates the depressed side.

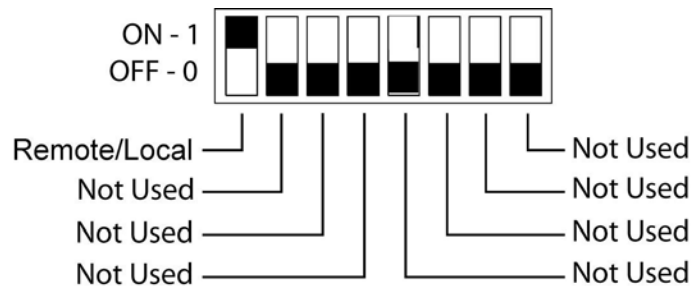

**Figure 2.1-5 DLM 600W Configuration Switch**

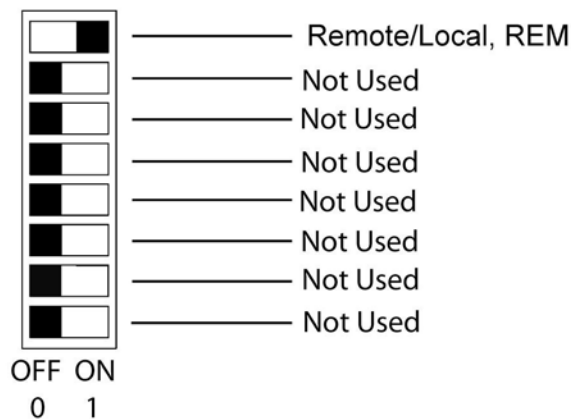

**Figure 2.1-6 DLM 600W Series w/M6 Option Configuration Switch**

Configuration	Description
ON	Remote operation selected. *
OFF	



## 2.1.6 External User Control Signal Connector

The external user control signal connector described in the M130/M131 Programming Manual, P/N M362797-03, and in the M9G manual, has been changed as it applies to the M6 Option. The end user will no longer have access to the following signals:

- POLARITY at pin 6
- ISOLATION at pin 7
- SENSE at pin 8

These signals are now utilized solely by the M6 card. The other signals remain as is.

An 8-pin Molex or 9-pin Subminiature-D connector located at the rear panel provides external auxiliary control signals to increase the user's operating control of the supply. The mating receptacle for the 8-pin connector is Molex 43025-0800 with 8 female terminals 43030-0003. The Molex terminals accommodate wire sizes from #20 - #24.

The relay outputs, when active, connect the POLARITY, SENSE, and ISOLATION pins of the connector to the relay COMMON pin. The relays are rated at 120VAC/125VDC @ 1A; for DLM Series 600W, maximum ratings are 60V(PK), 30VA, and 1A.

Any change in output (voltage, current, etc.) initiated by the user from the RS-232, GPIB, or Ethernet interface will cause a 10ms synchronization pulse to be generated at the rear panel User Control Signal Connector of the master unit (Sync Signal).

**Table 2.1-1 External User Control Signal Connector Pinout**

Sub-D Pin	Molex Pin	Description
1	1	For RS-232/GPIB: FOLDBACK output signal, open collector, active-low. Asserted when in foldback mode. Reserved function for Ethernet interface.
2	3	FAULT output signal, open collector, active-low. Asserted when a fault is recorded in the fault register.
3	6	<b>POLARITY - N/A - Used internally by the M6 Option</b>
4	7	<b>ISOLATION - N/A - Used internally by the M6 Option</b>
5	8	<b>SENSE - N/A - Used internally by the M6 Option</b>
6	2	SHUTDOWN TTL input signal, active-high. Allows the user to immediately shutdown the unit by a TTL input signal.
7	5	COMMON for all signals and relay contacts.
8	4	For RS-232/GPIB: SYNC output signal, open collector, active-low. Pulsed for 10 ms when a change in the output occurs. Reserved function for Ethernet interface.
9	—	COMMON for all signals and relay contacts.

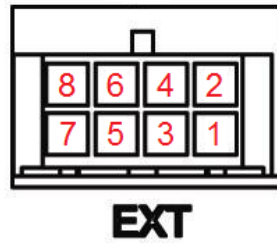

**Figure 2.1-7 External User Connector Designation (8-pin Molex)  
Viewed from Rear Panel of Unit**

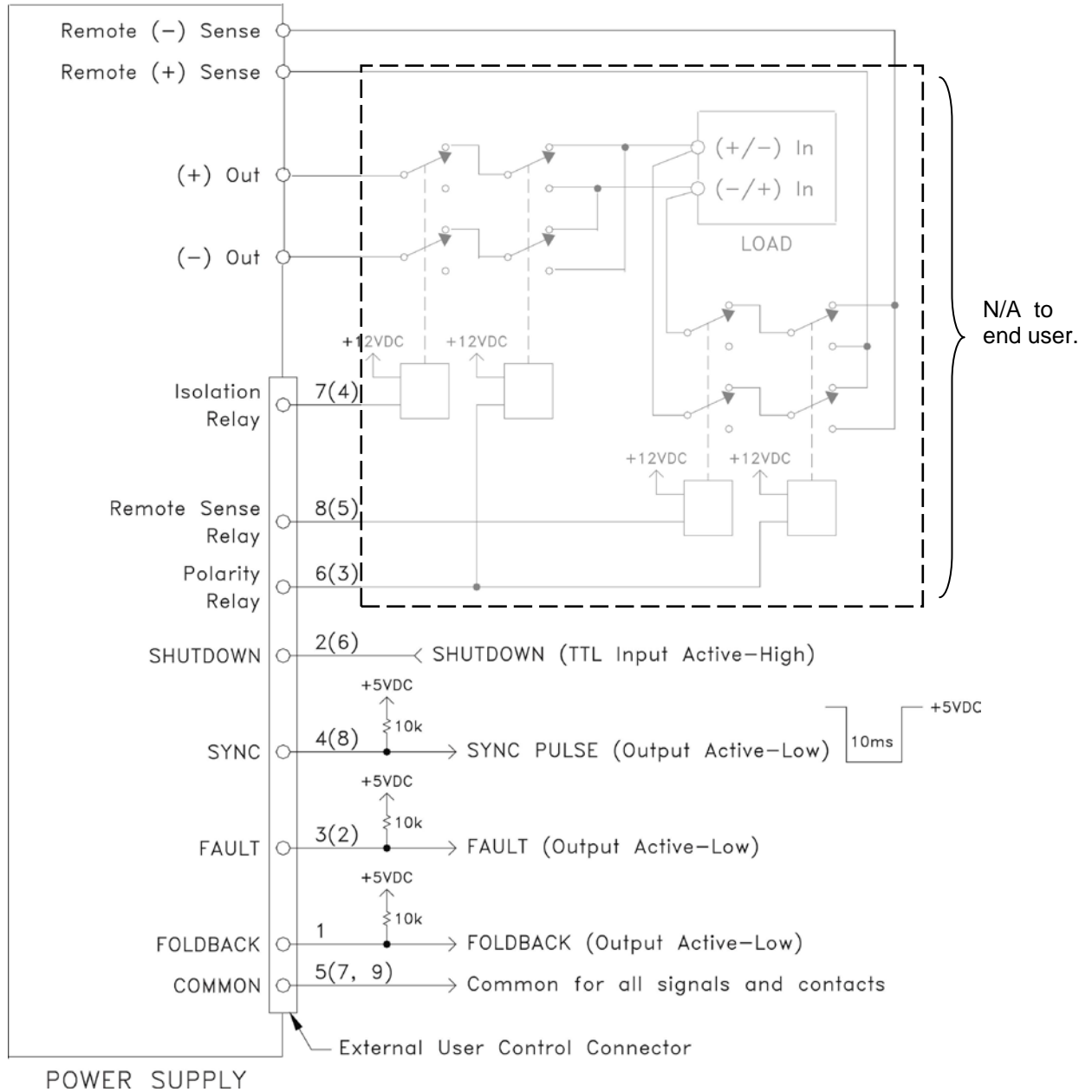

**Figure 2.1-8 Example of Open Collector, TTL Input, and Relay Output Circuits**

## 2.1.7 GPIB Address Switch

The GPIB SET UP DIP switch on the rear panel should always have the top switch **REM** on the ON position, for remote only. The front panel **REM** indicator should be on (green) at power up.

## 3.1 IEEE 488.2 and SCPI COMMAND OPERATION

The M9 and Relay PCB operation by remote programming using the M9 IEEE-488.2 and SCPI command sets are described in the section 3 of the M9 programming manual.

### 3.1.1 Useful Instructions

**The isolation relays may be accessed using the following instructions:**

If the **CAL:MOD:POWERON "ON,INIT"** command has been previously stored in the memory, then the following commands apply:

**OUTP:ISOL ON** ;Closes the output relays (K1 and K3)  
**OUTP:POL ON** ;Open K1 and K3 and close K2 and K4. Note that the algebraic sign of the voltage value must match the state of the polarity relay.  
**OUTP:SENS ON** ;Closes the external sense relay (K5). Note: this instruction, if required by the application, must be entered after the isolation (ISOL) instruction was sent.

If the **CAL:MOD :POWERON "OFF,INIT"** command has been previously stored in the memory, then the following commands apply:

**OUTP:STAT ON** ;Closes the output relays (K1 and K3)  
**OUTP:SENS ON** ;Closes the external sense relay (K5). Note: this instruction, if required by the application, must be entered after the isolation <**OUTP:STAT ON**> instruction was sent.

### 3.1.2 Additional Related Instructions

**CAL:MOD:ISOL 0** ;Relay open at power up  
**CAL:MOD:RESET "OFF,INIT"** ;Relay to remain open after reset  
**CAL:MOD :POWERON "ON,INIT"** ;Output goes to On state and is initialized

#### **FIXED OUTPUT POWER SUPPLY:**

**CAL:INIT:VOLT <value>** ;To store a fixed V-out available at power up  
**CAL:INIT:VOLT:PROT <value>** ;Over-voltage protection  
**CAL:INIT:CURR <value>** ;To store a fixed I-out available at power up

#### **MEMORY STORAGE INSTRUCTIONS:**

**CAL:UNLOCK "6867"** ;Security code to unlock and store

CAL:STORE  
CAL:LOCK

### 3.1.3 Polarity Relays

OUTP:POL INV ;output polarity relay will be engaged after the <ISOL> command  
OUTP:ISOL ON ;output polarity relays engaged.  
SOUR:CURR 10  
SOUR:VOLT -20 ;will read -20V at the output.

## 4.1 Remote Shutdown Operation, DLM Functionality (with Iso Relays)

### 1.1.3 Shutdown Trigger - TTLSD

- The output is inhibited with a TTL level high (5V).
- User to connect rear panel utility Digital I/O 8 pin J4 connector next to the GPIB; the pins are J4-2, TTLSD and GND J4-5.
- A high level will disable the output converter and open the relays for the duration of that level.
- The output voltage will be reduced to 0V in less than 50ms.
- When TTLSD level is back to low, the output will return to its previous value and the relay will remain open, disconnecting from the load.
- GPIB SRQ is possible if the faults event register is enabled and the TTLSD is high, a serial poll will return SRQ 49h.

#### LATCHED SHUTDOWN

- The relay will disconnect requiring a <\*RST> instruction and then you can reprogram the power supply. In addition, the end user could have the unit return an SRQ and use it within the shell program to, in turn, reset the unit.
- The fault event register must be enabled by the protection enable register to record in the fault register. The user can use it as filter and select specific events.
- Instructions:

```
*cls ; clears status register
*stb? ; reads register s/be "0"
sour:curr 5 ; regular instruction set current to 5A
sour:volt 25 ; regular instruction to set output voltage to 25V
outp:isol on ; regular instruction to turn on the isolation relays
stat:prot:enab 32 ; to enable bit 5 0x20 hex or 32 in decimal
*sre 2 ; bit 2 will cause a service request
```

At this point if the TTLSD is enabled....

```
serial poll ; to read SRQ
(ans) $42 ; 4 = service request and 2 = prot. Event bit
```

#### FRONT PANEL INDICATION

The output light will go off and the voltage and current displays will show 0's.

#### RECOVERING FROM THE SHUTDOWN EVENT (i.e. \*RST)

If the shell program resets the unit after the SRQ is acquired, then the unit is ready to be reprogrammed.

M9G Views

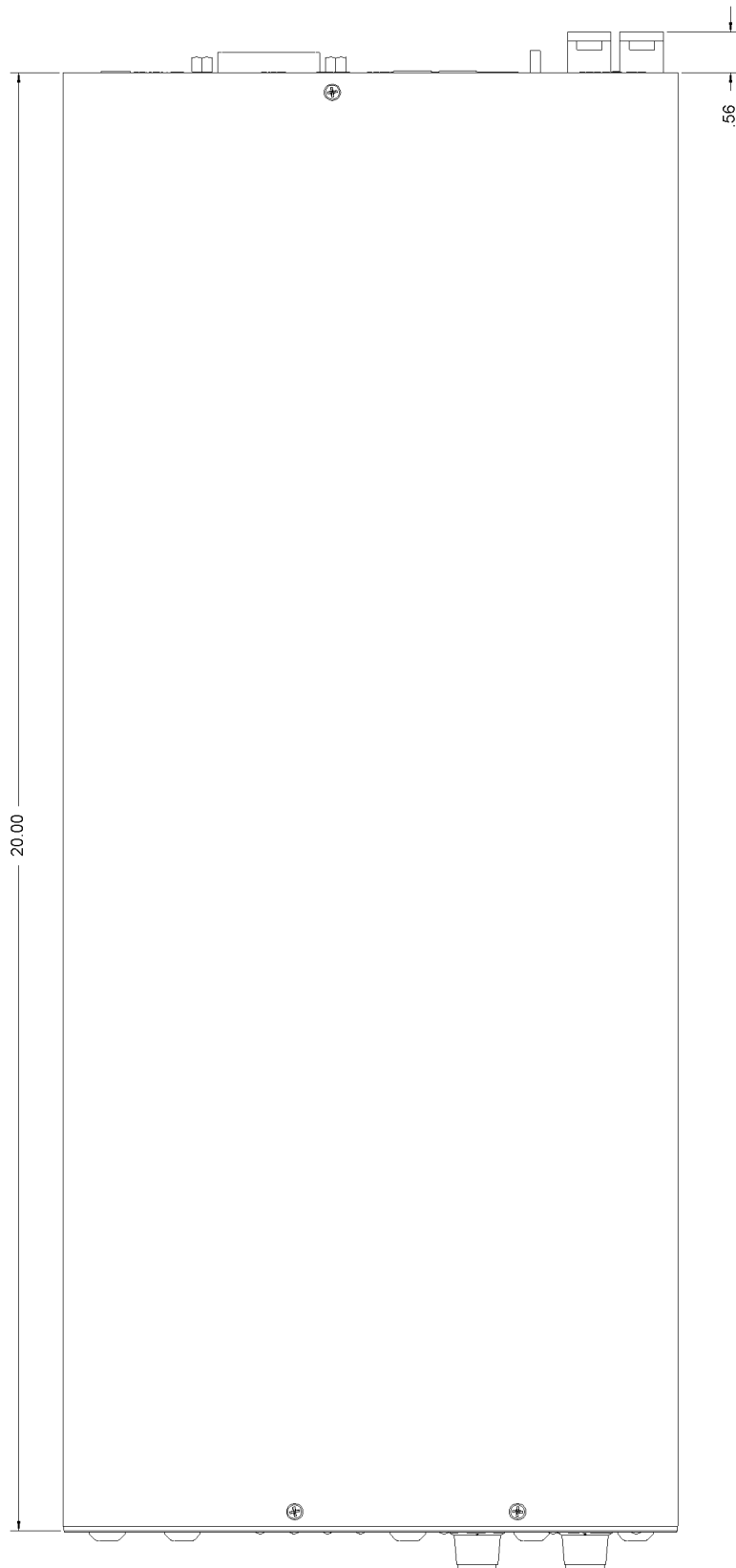

*DLM600 Top View*

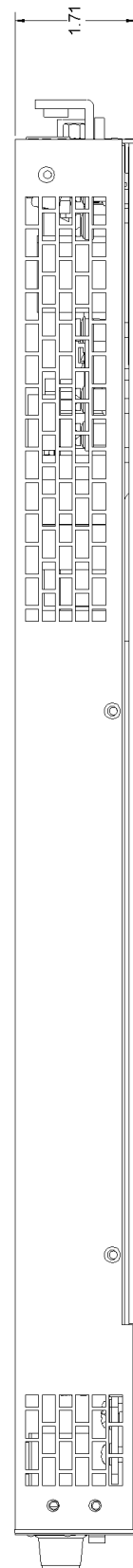

*DLM600 Side View*

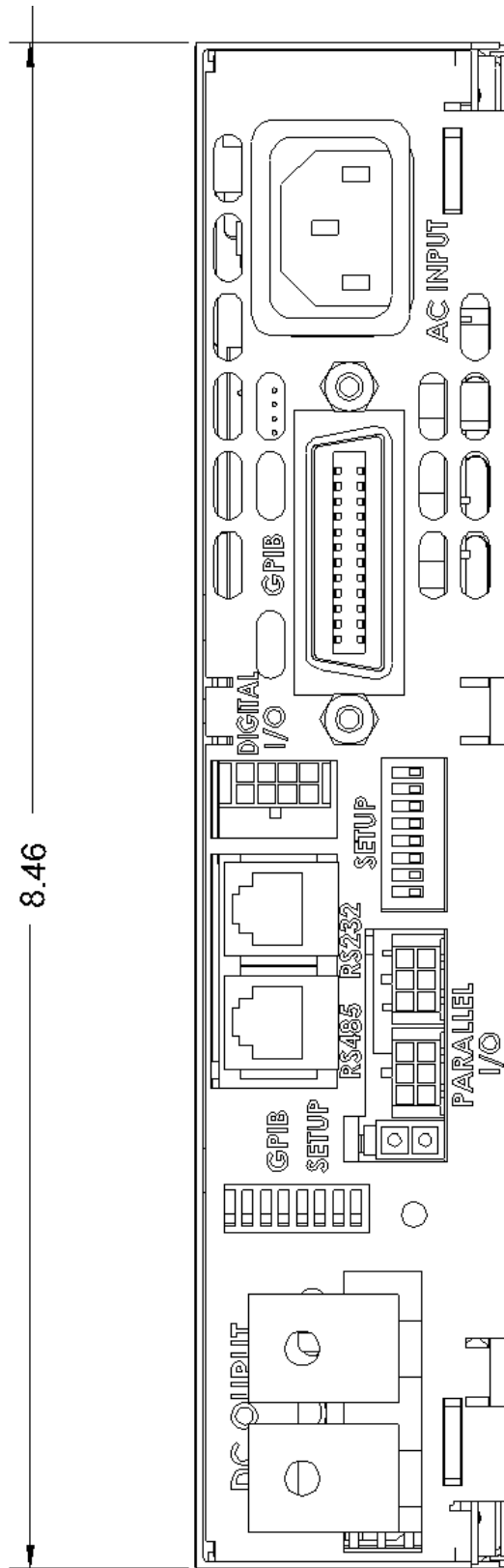

***DLM600 Rear View***

---

This page intentionally left blank.